

Product Specifications

NAME: DMX Common Controller
MODEL: KL-DMXTCON-4CH-LV(L=5,6,12,24)

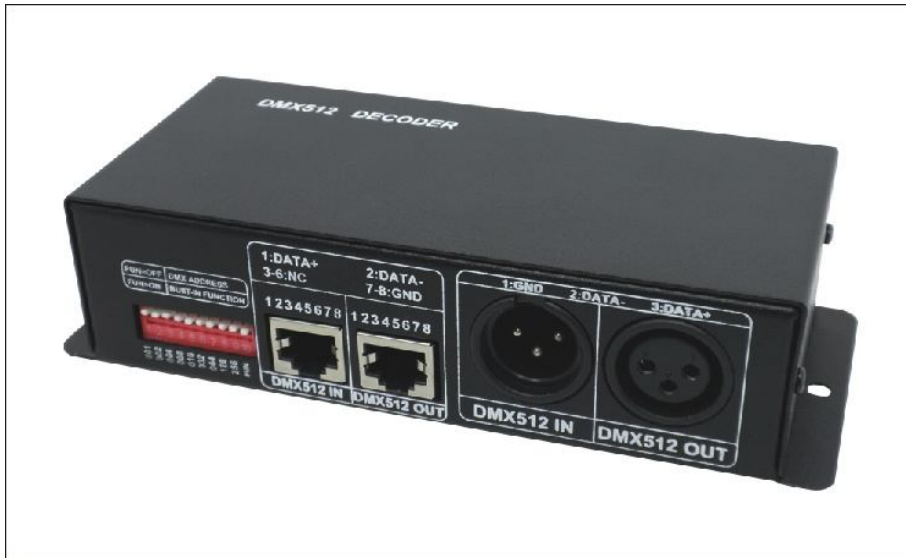

Summarization

DMX common controller adopts the advanced micro control unit, it receives standard DMX-512 digital control signal and transformed it into PWM signal for driving LED; You could connect DMX module with DMX digital console to achieve dimming or various changes in procedures.

Technical Parameters

- Working temperature: -20-60 °C
- Supply voltage: 12V~24VDC
- Output: 4 channels
- External dimension: L165×W68×H40 (mm)
- Packing size: L180×W95×H60 (mm)
- Net weight: 320g
- Gross weight: 355g
- Static power consumption: <1W
- Output current: each channel: 4A
- Output power: 5V:<160W, 12V:<432W, 24V:<864W

External Dimension

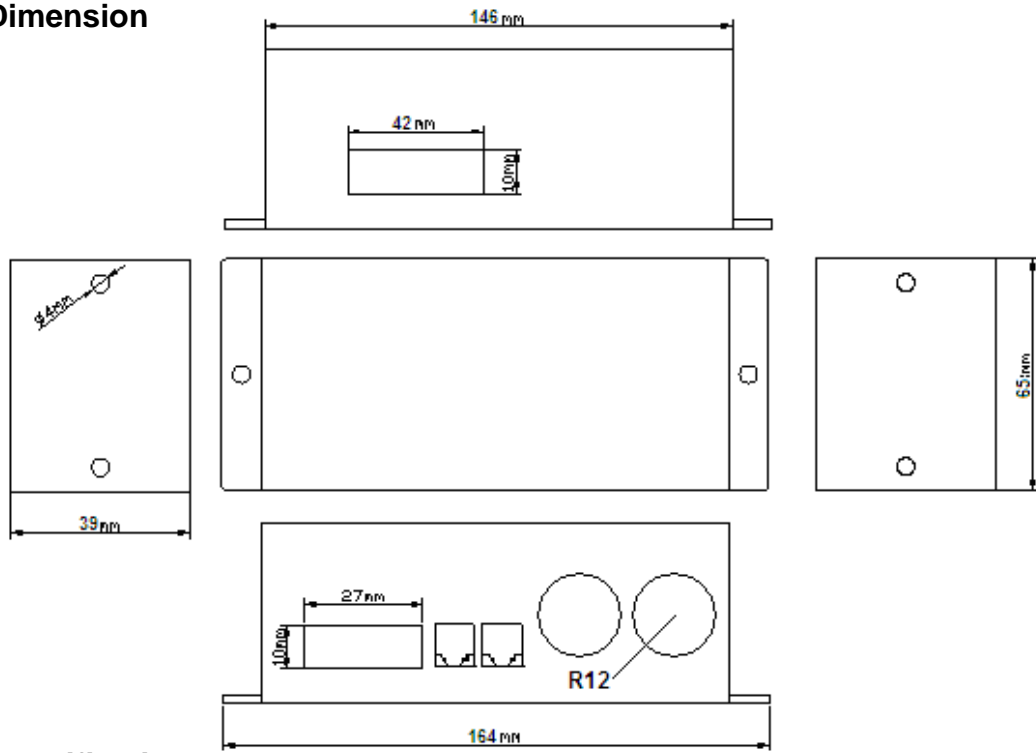

Interface specifications

DMX input/output interface:



The interface of settings for address code and function:

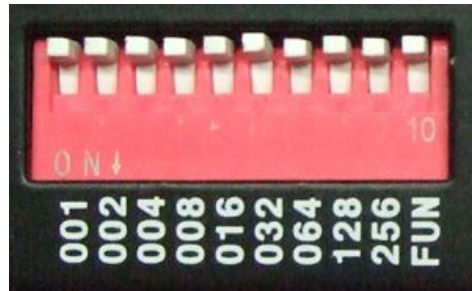

DMX input/output interface: RJ45 Interface

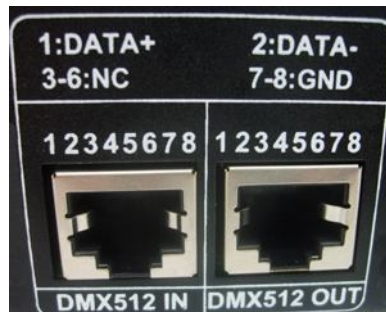

Supply power and load interface:

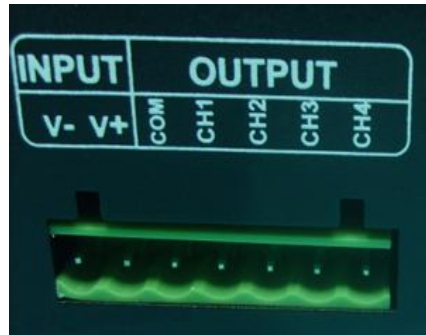

Direction for use

DMX address code settings

Each DMX common controller occupied 4 DMX addresses, adopt coding switch set address, it is a Binary numerical code switch which is setting DMX original address code from 1 to 9, 1 is the lowest, and 9 is the highest, 511 address codes could be setted in all. DMX original address code equal aggregate value of the coding switch value from 1 to 9, dial the coding switch upwards (ON is setted 1), the value of bit can be gotten, on the contrary, the value of bit is 0.

DMX signal can be received when coding switch FUN(10)=OFF (ON is setted 0).

1. example 1:

Look at the following picture, if you want to set 37 as the address code, you can only dial down the first, the third and the sixth code switch, the aggregate value of coding switch value from 1 to 9 is $32+4+1$, that is, the original address code of DMX512 is 37.

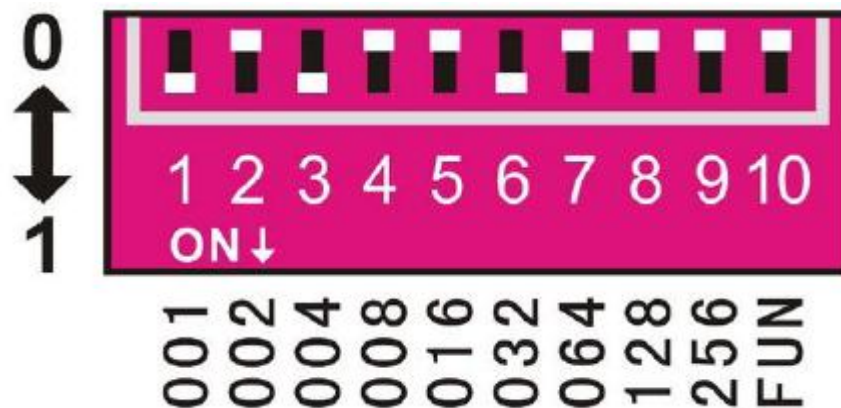

Picture 1

2. example 1:

Look at the following picture, if you want to set 328 as the address code, you can only dial down the ninth, the seventh and the fourth code switch, the aggregate value of coding switch value from 1 to 9 is $256+64+8$, that is, the original address code of DMX512 is 328.

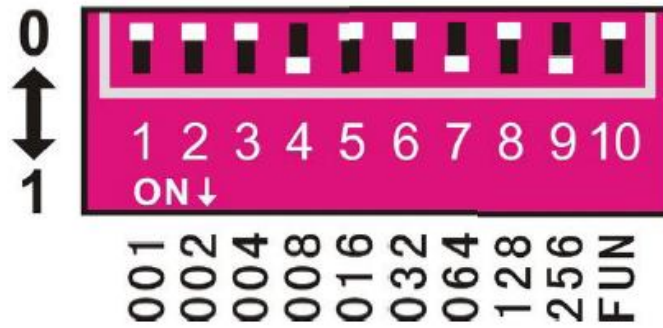

Picture 2

Other functions direction for use

1. Testing function:

The tenth bit of coding switch is 'FUN', that is a built-in function button. FUN=OFF shows the DMX decoder function, DMX signal can be received.

The default coding switch 1-9 is off: black

Switch 1=ON: CH1 bright

Switch 2=ON: CH2 bright

Switch 3=ON: CH3 bright

Switch 4=ON: CH4 bright

Switch 5=ON: 4 channels bright

Switch 6=ON: strobe (6 steps speed)

Switch 7=ON: horse racing (6 steps speed)

Switch 8=ON: running water (6 steps speed)

Switch 9=ON: seven-color gradual changing (6 steps speed)

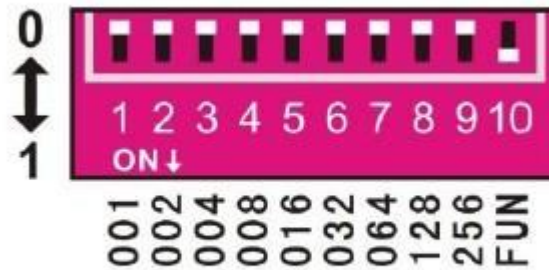

picture 3

2. The speed choice of strobe, horse running running water and gradual changing effect.

When test the function, switch 6=ON shows strobe effect, switch 7=ON shows horse racing effect, switch 8=ON is running water effect. switch 9=ON is gradual changing effect. Every effect has 6 steps speed:

Off switch from 1 to 7: 0 steps

Switch 1=ON: 1 steps

Switch 2=ON: 2 steps

Switch 3=ON: 3 steps

Switch 4=ON: 4 steps

Switch 5=ON: 5 steps (the fastest speed)

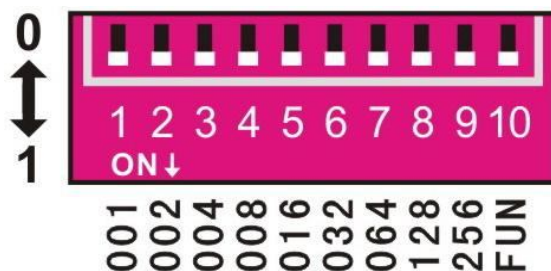

There are several switches=ON at the same time, the great value is standard. All dial code switches= ON as the following picture, the state of the decoder shows: to test the functional effects of gradual changing, the speed of change is 5.

Typical applications

The connection of low-power LED lamps:

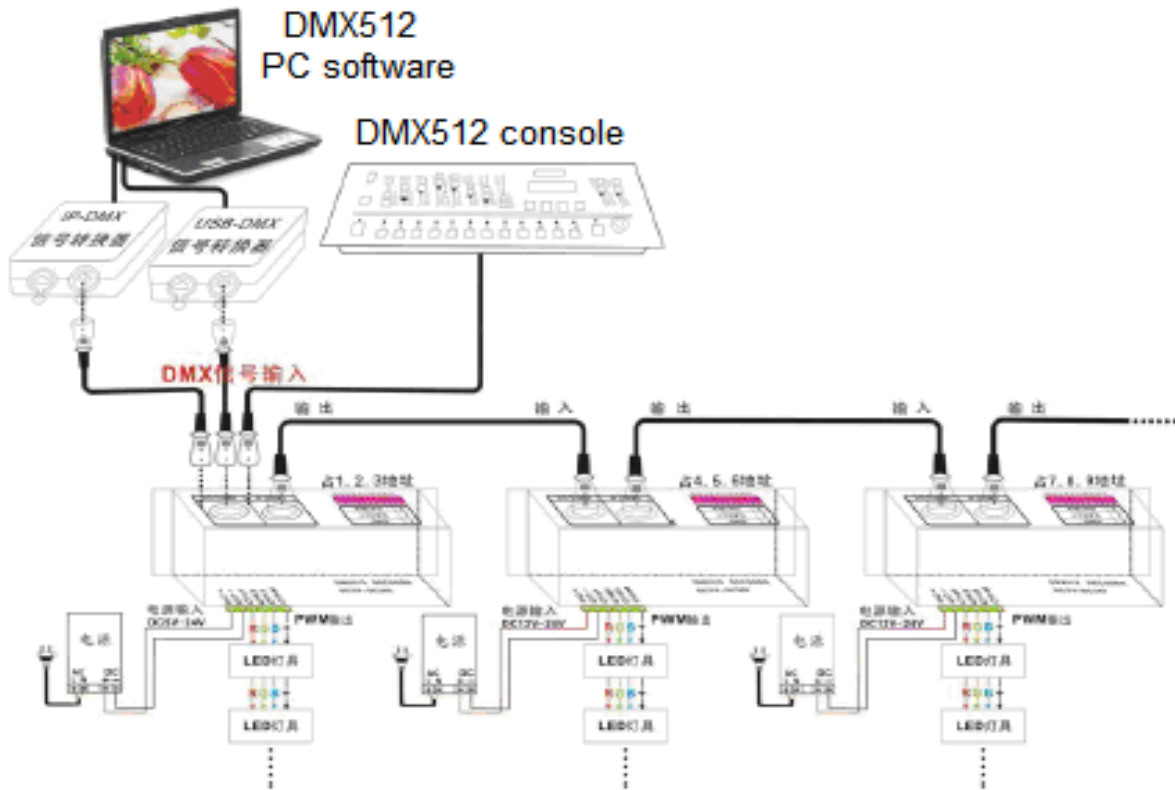

The connection of high-power LED lamps:

